



## PRODUCT FEATURES

VENTRA STERLING is a multi louvred ventilator that provides an economic, non-powered method of ventilation, allowing the removal of large quantities of warm air and / or smoke from a building within a short period of time.

The VENTRA STERLING is a further development on the already proven VENTRA but is a response to the increased requirements for air tightness and thermal insulation in certain building designs and applications worldwide. The VENTRA STERLING is suitable for fresh air supply (facade), air and smoke extraction (facade and roof) and natural lighting.

The vents are manufactured according to ISO 9001 quality control standards. The vents are formed from high quality corrosion resistant aluminium to ensure low maintenance requirements and water tightness.

Opening process available by pneumatic cylinder, electric motor or combined. The ventilator design produces a versatile economic unit suitable for a wide range of applications. Available on large dimensions, up to 2400 x 3826 mm (width x length).



# Ventra Sterling

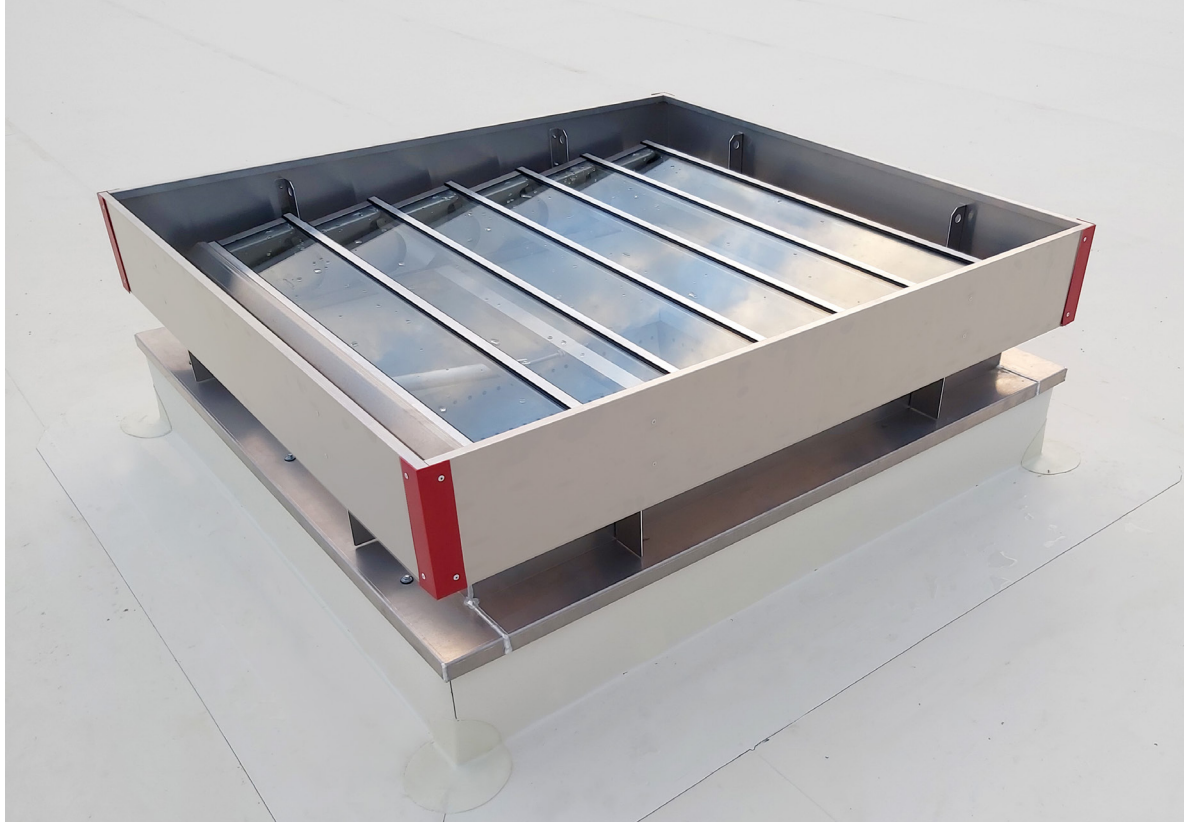

## TYPICAL APPLICATIONS

Versatile scope of applications on roofs and facades, with an installation angle range from 0° to 90°. Installations: industrial buildings, warehouses, logistics centres, shopping centres, atriums, schools, stairwells, among others.

## MATERIALS

Tempered aluminium, sea water- and corrosion-resistant (EN AW 5754).  
Corrosion resistant bearings.  
Built-in weather resistant hydrophobic tape.

*Note: aluminum is supplied untreated as standard. Possibility of being supplied with electrostatic painting (in any RAL color).*

## DIMENSIONS

**Roof opening width:** 300 - 2400 mm.  
**Roof opening length:** 746 - 3826 mm (17 louvres, max.).

## OPENING ANGLE

Individual adjustable from 0° up to 90°.

## CONTROLS NATURAL VENTILATION

**P1:** single pipe compressed operation.  
**P2:** double pipe compressed air operation.  
**M230V:** electric motor.  
**Combination set:** P1 + 230 V ou P2 + 230 V.

## CONTROLS FIRE VENTILATION

**P1F:** single pipe compressed air operation with fire function.  
**P2F:** double pipe compressed air operation with fire function.  
**M24V:** electric motor.

## LOUVRES

- SW** Sandwich panel 25 mm, U-Value=1,65 (W/(m<sup>2</sup>.K))
- PC25** Polycarbonate 25 mm / 9-X structure, clear or opal, U-Value=1,4 (W/(m<sup>2</sup>.K))
- GLASS** Insulated double glass 25 mm, U-Value= 1,1 (W/(m<sup>2</sup>.K))

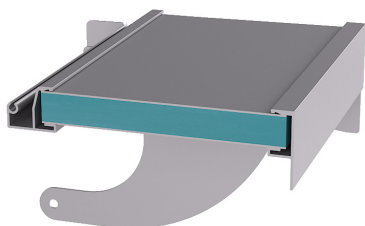

**SW**

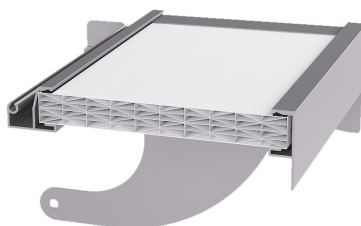

**PC25**

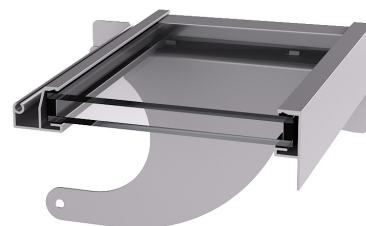

**GLASS**

## BASES

- Single aluminium.
- Double wall aluminium with insulation.

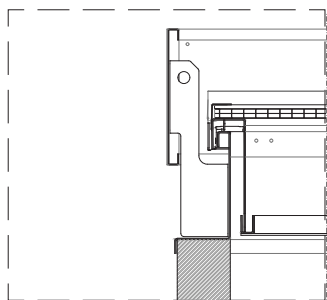

**DETAIL 01**  
single aluminium

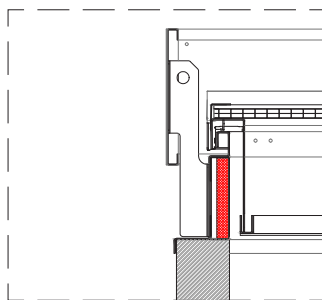

**DETAIL 02**  
double wall aluminium with insulation

## FLANGES

- S1** Flange for single glass.
- S2** Flange for double glass.
- S3** Flange for roofs, 45° bended.
- S4** Flange for roofs and facades.
- S5** Flange for upstand, 90° bended downwards.
- S6** Flange 90° bended upwards.
- SLS** Flange for skylight connection, for different polycarbonate thicknesses.
- SC** Flange for connection with other flange (vents connection). Male or female connection.
- SCM** Flange for male connection.
- SCF** Flange for female connection.

\* Custom flange design and insulated flanges upon request



**S1**



**S2**



**S3**



**S4**



**S5**



**S6**



**SLS**



**SC**



**SCM**



**SCF**

## DIMENSIONS/LOUVRES TABLE, SW/PC25mm

NUMBER OF LOUVRES															
	3	4	5	6	7	8	9	10	11	12	13	14	15	16	17
WIDTH (mm)	LENGTH (mm)														
300															
600															
1000	746	966	1186	1406	1626	1846	2066	2286	2506	2726	2946	3166	3386	3606	3826
...															
1800															
2000															
2400															

## DIMENSIONS/LOUVRES TABLE, GLASS

NUMBER OF LOUVRES														
	3	4	5	6	7	8	9	10	11	12	13	14	15	
WIDTH (mm)	LENGTH (mm)													
500-1100											2726	2946	3166	3386
1200-1700	746	966	1186	1406	1626	1846	2066	2286	2506		-	-	-	-

*Note: other dimensions upon request.*

## WEIGHT

Depends on dimensions and type of infill.

## OPTIONS

Custom dimensions.  
 Powder-coated design (any RAL colour).  
 Bird or insect mesh.  
 Anti-fall grid 1200 J.

## REGULATIONS

The system has been tested and is certified in accordance with EN 12101-2.

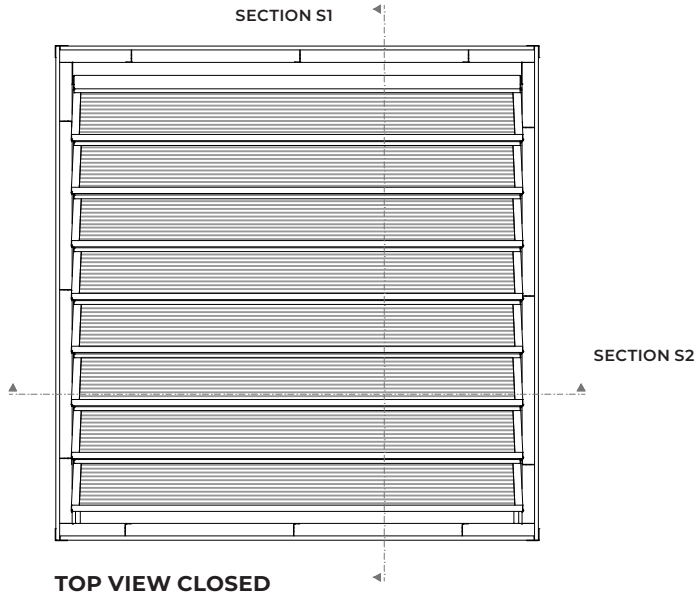

TOP VIEW CLOSED

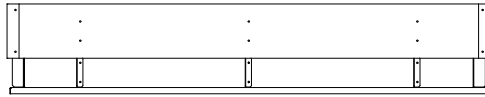

FRONT VIEW CLOSED

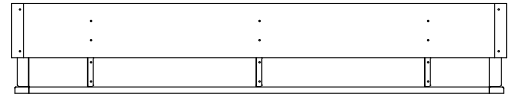

SIDE VIEW CLOSED

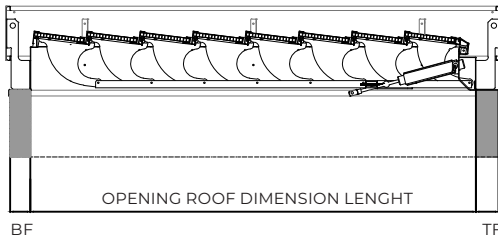

SECTION S1

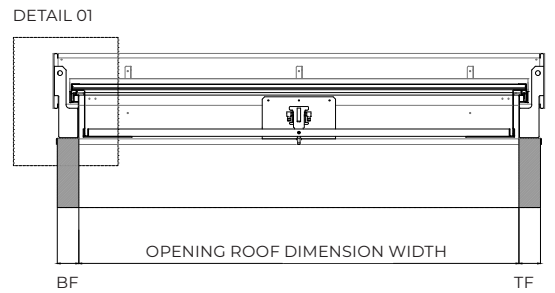

SECTION S2

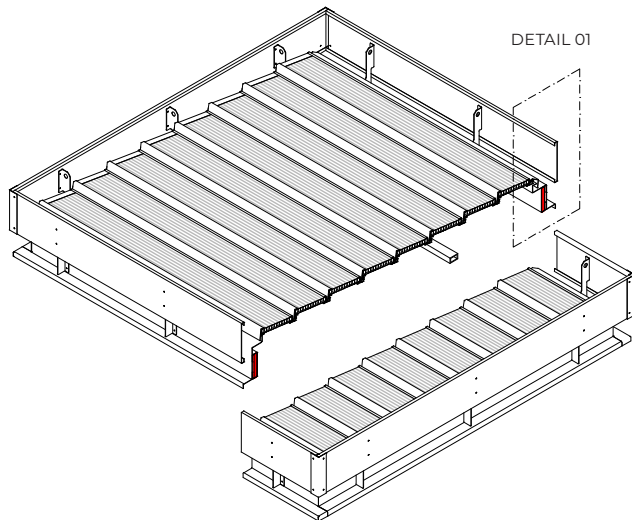

VENTRA INSULATED PERSPECTIVE